



Model Number

V1-W-1M-PVC

Female cordset, M12, 4-pin, PVC cable

Features

- Knurled nut suitable for tool assembly
- Immunity to vibration, with mechanical latching
- Degree of protection IP67 / IP68 / IP69K
- Gold-plated and machined contacts

Dimensions

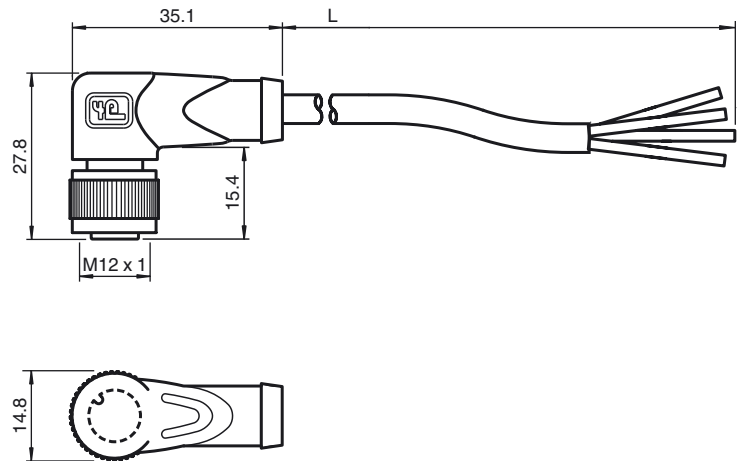

Technical data

General specifications

Number of pins	4
----------------	---

Electrical specifications

Operating voltage	U_B	max. 250 V AC/DC
Operating current	I_B	max. 4 A
Contact resistance		< 10 m Ω

Ambient conditions

Ambient temperature	Body: -40 ... 90 °C (-40 ... 194 °F) cable, fixed: -25 ... 70 °C (-13 ... 158 °F) cable, flexing: -5 ... 70 °C (23 ... 158 °F)
Pollution degree	3

Mechanical specifications

Contact elements	spring-loaded contact socket
Pin diameter	1 mm
Degree of protection	IP67 / IP68 / IP69k
Material	
Contacts	CuSn / Au
Contact surface	Au
Body	TPU, black
Cable	PVC
Slotted nut	Diecast zinc
Core insulation	PVC
Cable	fine-strand, flexible
Sheath diameter	Ø 4.8 mm
Bending radius	> 10 x cable diameter, moving
Color	grey
Cores	4 x 0.34 mm ²
Conductor construction	19 x 0.15 mm Ø
Length	L 1 m
Flammability	
Contact carrier	94 HB
Housing	94 V-2
Cable	flame-resistant

Compliance with standards and directives

Standard conformity	
Degree of protection	EN 60529:2000
Standards	IEC 61076-2-101:2008

Electrical connection

